



**In Clear Electronics**

[WWW.IC-1000.COM](http://WWW.IC-1000.COM)

## THE DATASHEET OF FPGA



[www.ic-1000.com](http://www.ic-1000.com)



[info@ic-1000.com](mailto:info@ic-1000.com)



[+00852-56412601](tel:+00852-56412601)



[+00852-56412601](https://wa.me/0085256412601)



Unit B, 13/F, Shing Lee Commercial Building  
No.8 Wing Kut Street, Central HK

## Features

- Optimized for 1.8V systems
  - As fast as 5.7 ns pin-to-pin delays
  - As low as 13  $\mu$ A quiescent current
- Industry's best 0.18 micron CMOS CPLD
  - Optimized architecture for effective logic synthesis
  - Multi-voltage I/O operation — 1.5V to 3.3V
- Available in multiple package options
  - 100-pin VQFP with 80 user I/O
  - 144-pin TQFP with 100 user I/O
  - 132-ball CP (0.5mm) BGA with 100 user I/O
  - Pb-free available for all packages
- Advanced system features
  - Fastest in system programming
    - 1.8V ISP using IEEE 1532 (JTAG) interface
  - IEEE1149.1 JTAG Boundary Scan Test
  - Optional Schmitt-trigger input (per pin)
  - Unsurpassed low power management
    - DataGATE enable (DGE) signal control
  - Two separate I/O banks
  - RealDigital 100% CMOS product term generation
  - Flexible clocking modes
    - Optional DualEDGE triggered registers
    - Clock divider (divide by 2,4,6,8,10,12,14,16)
    - CoolCLOCK
  - Global signal options with macrocell control
    - Multiple global clocks with phase selection per macrocell
    - Multiple global output enables
    - Global set/reset
  - Advanced design security
  - Open-drain output option for Wired-OR and LED drive
  - PLA architecture
    - Superior pinout retention
    - 100% product term routability across function block
  - Optional bus-hold, 3-state or weak pull-up on selected I/O pins
  - Optional configurable grounds on unused I/Os
  - Mixed I/O voltages compatible with 1.5V, 1.8V, 2.5V, and 3.3V logic levels
    - SSTL2-1, SSTL3-1, and HSTL-1 I/O compatibility
  - Hot pluggable

Refer to the CoolRunner™-II family data sheet for architecture description.

## Description

The CoolRunner-II 128-macrocell device is designed for both high performance and low power applications. This lends power savings to high-end communication equipment and high speed to battery operated devices. Due to the low power stand-by and dynamic operation, overall system reliability is improved.

This device consists of eight Function Blocks inter-connected by a low power Advanced Interconnect Matrix (AIM). The AIM feeds 40 true and complement inputs to each Function Block. The Function Blocks consist of a 40 by 56 P-term PLA and 16 macrocells which contain numerous configuration bits that allow for combinational or registered modes of operation.

Additionally, these registers can be globally reset or preset and configured as a D or T flip-flop or as a D latch. There are also multiple clock signals, both global and local product term types, configured on a per macrocell basis. Output pin configurations include slew rate limit, bus hold, pull-up, open drain and programmable grounds. A Schmitt-trigger input is available on a per input pin basis. In addition to storing macrocell output states, the macrocell registers may be configured as direct input registers to store signals directly from input pins.

Clocking is available on a global or Function Block basis. Three global clocks are available for all Function Blocks as a synchronous clock source. Macrocell registers can be individually configured to power up to the zero or one state. A global set/reset control line is also available to asynchronously set or reset selected registers during operation. Additional local clock, synchronous clock-enable, asynchronous set/reset and output enable signals can be formed using product terms on a per-macrocell or per-Function Block basis.

A DualEDGE flip-flop feature is also available on a per macrocell basis. This feature allows high performance synchronous operation based on lower frequency clocking to help reduce the total power consumption of the device.

Circuitry has also been included to divide one externally supplied global clock (GCK2) by eight different selections. This yields divide by even and odd clock frequencies.

The use of the clock divide (division by 2) and DualEDGE flip-flop gives the resultant CoolCLOCK feature.

DataGATE is a method to selectively disable inputs of the CPLD that are not of interest during certain points in time.

By mapping a signal to the DataGATE function, lower power can be achieved due to reduction in signal switching.

Another feature that eases voltage translation is I/O banking. Two I/O banks are available on the CoolRunner-II 128 macrocell device that permit easy interfacing to 3.3V, 2.5V, 1.8V, and 1.5V devices.

The CoolRunner-II 128 macrocell CPLD is I/O compatible with various JEDEC I/O standards (see [Table 1](#)). This device is also 1.5V I/O compatible with the use of Schmitt-trigger inputs.

## RealDigital Design Technology

Xilinx CoolRunner-II CPLDs are fabricated on a 0.18 micron process technology which is derived from leading edge FPGA product development. CoolRunner-II CPLDs employ RealDigital technology, a design technique that makes use of CMOS technology in both the fabrication and design methodology. RealDigital technology employs a cascade of CMOS gates to implement sum of products instead of traditional sense amplifier methodology. Due to this technology, Xilinx CoolRunner-II CPLDs achieve both high-performance and low power operation.

## Supported I/O Standards

The CoolRunner-II 128 macrocell features LVCMOS, LVTTTL, SSTL and HSTL I/O implementations. See [Table 1](#)

for I/O standard voltages. The LVTTTL I/O standard is a general purpose EIA/JEDEC standard for 3.3V applications that use an LVTTTL input buffer and Push-Pull output buffer. The LVCMOS standard is used in 3.3V, 2.5V, 1.8V applications. Both HSTL and SSTL make use of a  $V_{REF}$  pin for JEDEC compliance. CoolRunner-II CPLDs are also 1.5V I/O compatible with the use of Schmitt-trigger inputs.

Table 1: I/O Standards for XC2C128<sup>(1)</sup>

IOSTANDARD Attribute	Output $V_{CCIO}$	Input $V_{CCIO}$	Input $V_{REF}$	Board Termination Voltage $V_{TT}$
LVTTTL	3.3	3.3	N/A	N/A
LVCMOS33	3.3	3.3	N/A	N/A
LVCMOS25	2.5	2.5	N/A	N/A
LVCMOS18	1.8	1.8	N/A	N/A
LVCMOS15 <sup>(2)</sup>	1.5	1.5	N/A	N/A
HSTL_1	1.5	1.5	0.75	0.75
SSTL2_1	2.5	2.5	1.25	1.25
SSTL3_1	3.3	3.3	1.5	1.5

(1) For information on assigning Vref pins, see [XAPP399](#)

(2) LVCMOS15 requires use of Schmitt-trigger inputs.

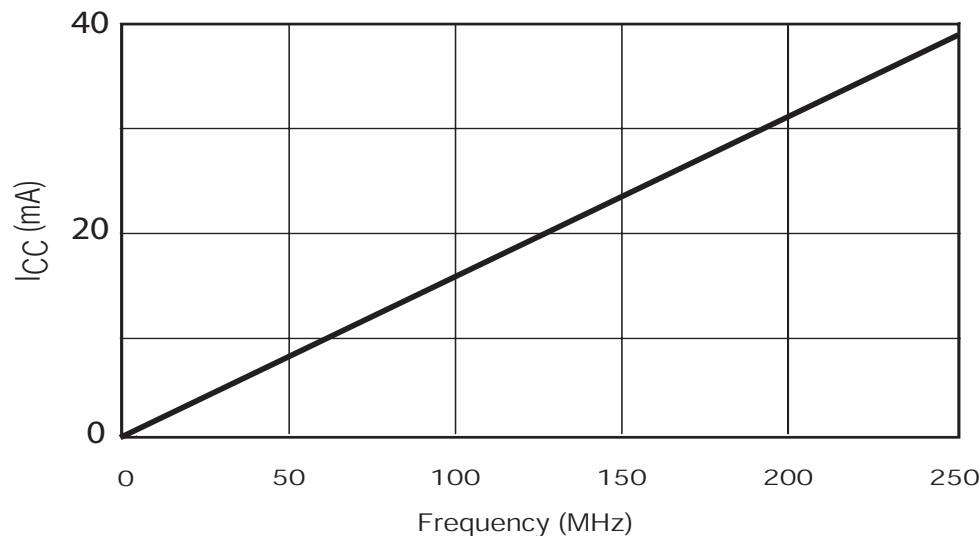

Figure 1:  $I_{CC}$  vs Frequency

Table 2:  $I_{CC}$  vs Frequency (LVCMOS 1.8V  $T_A = 25^\circ\text{C}$ )<sup>(1)</sup>

	Frequency (MHz)									
	0	25	50	75	100	150	175	200	225	250
Typical $I_{CC}$ (mA)	0.019	3.97	7.95	11.92	15.89	23.83	27.80	31.93	35.73	39.70

### Notes:

- 16-bit up/down, Resettable binary counter (one counter per function block).

## Absolute Maximum Ratings

Symbol	Description	Value	Units
$V_{CC}$	Supply voltage relative to ground	-0.5 to 2.0	V
$V_{CCIO}$	Supply voltage for output drivers	-0.5 to 4.0	V
$V_{JTAG}^{(2)}$	JTAG input voltage limits	-0.5 to 4.0	V
$V_{CCAUX}$	JTAG input supply voltage	-0.5 to 4.0	V
$V_{IN}^{(1)}$	Input voltage relative to ground	-0.5 to 4.0	V
$V_{TS}^{(1)}$	Voltage applied to 3-state output	-0.5 to 4.0	V
$T_{STG}^{(3)}$	Storage Temperature (ambient)	-65 to +150	°C
$T_J$	Junction Temperature	+ 150	°C

**Notes:**

- Maximum DC undershoot below GND must be limited to either 0.5V or 10 mA, whichever is easiest to achieve. During transitions, the device pins may undershoot to -2.0V or overshoot to +4.5V, provided this over or undershoot lasts less than 10 ns and with the forcing current being limited to 200 mA.
- Valid over commercial temperature range.
- For soldering guidelines and thermal considerations, see the [Device Packaging](#) information on the Xilinx website. For Pb-free packages, see [XAPP427](#).

## Recommended Operating Conditions

Symbol	Parameter		Min	Max	Units
$V_{CC}$	Supply voltage for internal logic and input buffers	Commercial $T_A = 0^\circ\text{C}$ to $+70^\circ\text{C}$	1.7	1.9	V
		Industrial $T_A = -40^\circ\text{C}$ to $+85^\circ\text{C}$	1.7	1.9	V
$V_{CCIO}$	Supply voltage for output drivers @ 3.3V operation		3.0	3.6	V
	Supply voltage for output drivers @ 2.5V operation		2.3	2.7	V
	Supply voltage for output drivers @ 1.8V operation		1.7	1.9	V
	Supply voltage for output drivers @ 1.5V operation		1.4	1.6	V
$V_{CCAUX}$	Supply voltage for JTAG programming		1.7	3.6	V

## DC Electrical Characteristics (Over Recommended Operating Conditions)

Symbol	Parameter	Test Conditions	Typical	Max.	Units
$I_{CCSB}$	Standby current Commercial	$V_{CC} = 1.9\text{V}$ , $V_{CCIO} = 3.6\text{V}$	30	120	$\mu\text{A}$
$I_{CCSB}$	Standby current Industrial	$V_{CC} = 1.9\text{V}$ , $V_{CCIO} = 3.6\text{V}$	60	200	$\mu\text{A}$
$I_{CC}^{(1)}$	Dynamic current	$f = 1\text{ MHz}$	-	500	$\mu\text{A}$
		$f = 50\text{ MHz}$	-	10	mA
$C_{JTAG}$	JTAG input capacitance	$f = 1\text{ MHz}$	-	10	pF
$C_{CLK}$	Global clock input capacitance	$f = 1\text{ MHz}$	-	12	pF
$C_{IO}$	I/O capacitance	$f = 1\text{ MHz}$	-	10	pF
$I_{IL}^{(2)}$	Input leakage current	$V_{IN} = 0\text{V}$ or $V_{CCIO}$ to 3.9V	-	+/-1	$\mu\text{A}$
$I_{IH}^{(2)}$	I/O High-Z leakage	$V_{IN} = 0\text{V}$ or $V_{CCIO}$ to 3.9V	-	+/-1	$\mu\text{A}$

**Notes:**

- 16-bit up/down, Resettable binary counter (one counter per function block).
- See Quality and Reliability section in CoolRunner-II family data sheet for details.

## LVC MOS and LV TTL 3.3V DC Voltage Specifications

Symbol	Parameter	Test Conditions	Min.	Max.	Units
$V_{CCIO}$	Input source voltage		3.0	3.6	V
$V_{IH}$	High level input voltage		2.0	3.9	V
$V_{IL}$	Low level input voltage		-0.3	0.8	V
$V_{OH}$	High level output voltage	$I_{OH} = -8 \text{ mA}, V_{CCIO} = 3\text{V}$	$V_{CCIO} - 0.4\text{V}$	-	V
		$I_{OH} = -0.1 \text{ mA}, V_{CCIO} = 3\text{V}$	$V_{CCIO} - 0.2\text{V}$	-	V
$V_{OL}$	Low level output voltage	$I_{OL} = 8 \text{ mA}, V_{CCIO} = 3\text{V}$	-	0.4	V
		$I_{OL} = 0.1 \text{ mA}, V_{CCIO} = 3\text{V}$	-	0.2	V

## LVC MOS 2.5V DC Voltage Specifications

Symbol	Parameter	Test Conditions	Min.	Max.	Units
$V_{CCIO}$	Input source voltage		2.3	2.7	V
$V_{IH}$	High level input voltage		1.7	$V_{CCIO} + 0.3^{(1)}$	V
$V_{IL}$	Low level input voltage		-0.3	0.7	V
$V_{OH}$	High level output voltage	$I_{OH} = -8 \text{ mA}, V_{CCIO} = 2.3\text{V}$	$V_{CCIO} - 0.4\text{V}$	-	V
		$I_{OH} = -0.1 \text{ mA}, V_{CCIO} = 2.3\text{V}$	$V_{CCIO} - 0.2\text{V}$	-	V
$V_{OL}$	Low level output voltage	$I_{OL} = 8 \text{ mA}, V_{CCIO} = 2.3\text{V}$	-	0.4	V
		$I_{OL} = 0.1 \text{ mA}, V_{CCIO} = 2.3\text{V}$	-	0.2	V

(1) The  $V_{IH}$  Max value represents the JEDEC specification for LVC MOS25. The CoolRunner-II input buffer can tolerate up to 3.9V without physical damage.

## LVC MOS 1.8V DC Voltage Specifications

Symbol	Parameter	Test Conditions	Min.	Max.	Units
$V_{CCIO}$	Input source voltage		1.7	1.9	V
$V_{IH}$	High level input voltage		$0.65 \times V_{CCIO}$	$V_{CCIO} + 0.3^{(1)}$	V
$V_{IL}$	Low level input voltage		-0.3	$0.35 \times V_{CCIO}$	V
$V_{OH}$	High level output voltage	$I_{OH} = -8 \text{ mA}, V_{CCIO} = 1.7\text{V}$	$V_{CCIO} - 0.45$	-	V
		$I_{OH} = -0.1 \text{ mA}, V_{CCIO} = 1.7\text{V}$	$V_{CCIO} - 0.2$	-	V
$V_{OL}$	Low level output voltage	$I_{OL} = 8 \text{ mA}, V_{CCIO} = 1.7\text{V}$	-	0.45	V
		$I_{OL} = 0.1 \text{ mA}, V_{CCIO} = 1.7\text{V}$	-	0.2	V

(1) The  $V_{IH}$  Max value represents the JEDEC specification for LVC MOS18. The CoolRunner-II input buffer can tolerate up to 3.9V without physical damage.

## LVC MOS 1.5V DC Voltage Specifications<sup>(1)</sup>

Symbol	Parameter	Test Conditions	Min.	Max.	Units
$V_{CCIO}$	Input source voltage		1.4	1.6	V
$V_{T+}$	Input hysteresis threshold voltage		$0.5 \times V_{CCIO}$	$0.8 \times V_{CCIO}$	V
$V_{T-}$			$0.2 \times V_{CCIO}$	$0.5 \times V_{CCIO}$	V
$V_{OH}$	High level output voltage	$I_{OH} = -8 \text{ mA}, V_{CCIO} = 1.4\text{V}$	$V_{CCIO} - 0.45$		V
		$I_{OH} = -0.1 \text{ mA}, V_{CCIO} = 1.4\text{V}$	$V_{CCIO} - 0.2$		V

Symbol	Parameter	Test Conditions	Min.	Max.	Units
V <sub>OL</sub>	Low level output voltage	I <sub>OL</sub> = 8 mA, V <sub>CCIO</sub> = 1.4V		0.4	V
		I <sub>OL</sub> = 0.1 mA, V <sub>CCIO</sub> = 1.4V		0.2	V

**Notes:**

1. Hysteresis used on 1.5V inputs.

## Schmitt Trigger Input DC Voltage Specifications

Symbol	Parameter	Test Conditions	Min.	Max.	Units
V <sub>CCIO</sub>	Input source voltage		1.4	3.9	V
V <sub>T+</sub>	Input hysteresis threshold voltage		0.5 x V <sub>CCIO</sub>	0.8 x V <sub>CCIO</sub>	V
V <sub>T-</sub>			0.2 x V <sub>CCIO</sub>	0.5 x V <sub>CCIO</sub>	V

## SSTL2-1 DC Voltage Specifications

Symbol	Parameter	Test Conditions	Min.	Typ.	Max.	Units
V <sub>CCIO</sub>	Input source voltage		2.3	2.5	2.7	V
V <sub>REF</sub> <sup>(1)</sup>	Input reference voltage		1.15	1.25	1.35	V
V <sub>TT</sub> <sup>(2)</sup>	Termination voltage		V <sub>REF</sub> - 0.04	1.25	V <sub>REF</sub> + 0.04	V
V <sub>IH</sub>	High level input voltage		V <sub>REF</sub> + 0.18	-	3.9	V
V <sub>IL</sub>	Low level input voltage		-0.3	-	V <sub>REF</sub> - 0.18	V
V <sub>OH</sub>	High level output voltage	I <sub>OH</sub> = -8 mA, V <sub>CCIO</sub> = 2.3V	V <sub>CCIO</sub> - 0.62	-	-	V
V <sub>OL</sub>	Low level output voltage	I <sub>OL</sub> = 8 mA, V <sub>CCIO</sub> = 2.3V	-	-	0.54	V

**Notes:**

1. V<sub>REF</sub> should track the variations in V<sub>CCIO</sub>, also peak to peak ac noise on V<sub>REF</sub> may not exceed ±2% V<sub>REF</sub>.
2. V<sub>TT</sub> of transmitting device must track V<sub>REF</sub> of receiving devices.

## SSTL3-1 DC Voltage Specifications

Symbol	Parameter	Test Conditions	Min.	Typ.	Max.	Units
V <sub>CCIO</sub>	Input source voltage		3.0	3.3	3.6	V
V <sub>REF</sub> <sup>(1)</sup>	Input reference voltage		1.3	1.5	1.7	V
V <sub>TT</sub> <sup>(2)</sup>	Termination voltage		V <sub>REF</sub> - 0.05	1.5	V <sub>REF</sub> + 0.05	V
V <sub>IH</sub>	High level input voltage		V <sub>REF</sub> + 0.2	-	V <sub>CCIO</sub> + 0.3	V
V <sub>IL</sub>	Low level input voltage		-0.3	-	V <sub>REF</sub> - 0.2	V
V <sub>OH</sub>	High level output voltage	I <sub>OH</sub> = -8 mA, V <sub>CCIO</sub> = 3V	V <sub>CCIO</sub> - 1.1	-	-	V
V <sub>OL</sub>	Low level output voltage	I <sub>OL</sub> = 8 mA, V <sub>CCIO</sub> = 3V	-	-	0.7	V

**Notes:**

1. V<sub>REF</sub> should track the variations in V<sub>CCIO</sub>, also peak to peak ac noise on V<sub>REF</sub> may not exceed ±2% V<sub>REF</sub>.
2. V<sub>TT</sub> of transmitting device must track V<sub>REF</sub> of receiving devices.

## HSTL1 DC Voltage Specifications

Symbol	Parameter	Test Conditions	Min.	Typ.	Max.	Units
V <sub>CCIO</sub>	Input source voltage		1.4	1.5	1.6	V
V <sub>REF</sub> <sup>(1)</sup>	Input reference voltage		0.68	0.75	0.90	V
V <sub>TT</sub> <sup>(2)</sup>	Termination voltage			V <sub>CCIO</sub> x 0.5		V
V <sub>IH</sub>	High level input voltage		V <sub>REF</sub> + 0.1	-	1.9	V
V <sub>IL</sub>	Low level input voltage		-0.3	-	V <sub>REF</sub> - 0.1	V

Symbol	Parameter	Test Conditions	Min.	Typ.	Max.	Units
$V_{OH}$	High level output voltage	$I_{OH} = -8 \text{ mA}$ , $V_{CCIO} = 1.7V$	$V_{CCIO} - 0.4$	-	-	V
$V_{OL}$	Low level output voltage	$I_{OL} = 8 \text{ mA}$ , $V_{CCIO} = 1.7V$	-	-	0.4	V

**Notes:**

- $V_{REF}$  should track the variations in  $V_{CCIO}$ , also peak to peak ac noise on  $V_{REF}$  may not exceed  $\pm 2\%$   $V_{REF}$ .
- $V_{TT}$  of transmitting device must track  $V_{REF}$  of receiving devices.

## AC Electrical Characteristics Over Recommended Operating Conditions

Symbol	Parameter	-6		-7		Units
		Min.	Max.	Min.	Max.	
T <sub>PD1</sub>	Propagation delay single p-term	-	5.7	-	7.0	ns
T <sub>PD2</sub>	Propagation delay OR array	-	6.0	-	7.5	ns
T <sub>SUD</sub>	Direct input register set-up time	3.6	-	4.6	-	ns
T <sub>SU1</sub>	Setup time fast (single p-term)	2.4	-	3.0	-	ns
T <sub>SU2</sub>	Setup time (OR array)	2.7	-	3.5	-	ns
T <sub>HD</sub>	Direct input register hold time	0.0	-	0.0	-	ns
T <sub>H</sub>	Hold time (Or array or p-term)	0.0	-	0.0	-	ns
T <sub>CO</sub>	Clock to output	-	4.2	-	5.4	ns
F <sub>TOGGLE</sub> <sup>(1)</sup>	Internal toggle rate	-	450	-	300	MHz
F <sub>SYSTEM1</sub> <sup>(2)</sup>	Maximum system frequency	-	244	-	152	MHz
F <sub>SYSTEM2</sub> <sup>(2)</sup>	Maximum system frequency	-	227	-	141	MHz
F <sub>EXT1</sub> <sup>(3)</sup>	Maximum external frequency	-	152	-	119	MHz
F <sub>EXT2</sub> <sup>(3)</sup>	Maximum external frequency	-	145	-	112	MHz
T <sub>PSUD</sub>	Direct input register p-term clock setup time	2.5	-	3.1	-	ns
T <sub>PSU1</sub>	P-term clock setup time (single p-term)	1.3	-	1.5	-	ns
T <sub>PSU2</sub>	P-term clock setup time (OR array)	1.6	-	2.0	-	ns
T <sub>PHD</sub>	Direct input register p-term clock hold time	0.2	-	0.2	-	ns
T <sub>PH</sub>	P-term clock hold	0.7	-	1.0	-	ns
T <sub>PCO</sub>	P-term clock to output	-	5.9	-	7.3	ns
T <sub>OE</sub> /T <sub>OD</sub>	Global OE to output enable/disable	-	5.9	-	7.5	ns
T <sub>POE</sub> /T <sub>POD</sub>	P-term OE to output enable/disable	-	7.0	-	8.5	ns
T <sub>MOE</sub> /T <sub>MOD</sub>	Macrocell driven OE to output enable/disable	-	7.7	-	9.9	ns
T <sub>PAO</sub>	P-term set/reset to output valid	-	6.6	-	8.1	ns
T <sub>AO</sub>	Global set/reset to output valid	-	5.0	-	7.6	ns
T <sub>SUEC</sub>	Register clock enable setup time	3.1	-	3.5	-	ns
T <sub>HEC</sub>	Register clock enable hold time	0.0	-	0.0	-	ns
T <sub>CW</sub>	Global clock pulse width High or Low	1.1	-	1.6	-	ns
T <sub>APRPW</sub>	Asynchronous preset/reset pulse width (High or Low)	6.0	-	7.5	-	ns
T <sub>PCW</sub>	P-term pulse width High or Low	6.0	-	7.5	-	ns
T <sub>DGSU</sub>	Set-up before DataGATE latch assertion	0.0	-	0.0	-	ns
T <sub>DGH</sub>	Hold to DataGATE latch assertion	4.0	-	6.0	-	ns
T <sub>DGR</sub>	DataGATE recovery to new data	-	8.2	-	9.0	ns
T <sub>DGW</sub>	DataGATE low pulse width	3.0	-	4.0	-	ns
T <sub>CDRSU</sub>	CDRST setup time before falling edge GCLK2	1.3	-	2.0	-	ns
T <sub>CDRH</sub>	Hold time CDRST after falling edge GCLK2	0.0	-	0.0	-	ns
T <sub>CONFIG</sub> <sup>(4)</sup>	Configuration time	-	350	-	350	us

### Notes:

1. F<sub>TOGGLE</sub> is the maximum clock frequency to which a T flip-flop can reliably toggle (see the CoolRunner-II family data sheet).
2. F<sub>SYSTEM1</sub> is the internal operating frequency for a device with 16-bit resettable binary counter through one p-term per macrocell while F<sub>SYSTEM2</sub> is through the OR array (one counter per function block).
3. F<sub>EXT1</sub> (1/T<sub>SU1</sub>+T<sub>CO</sub>) is the maximum external frequency using one p-term while F<sub>EXT2</sub> is through the OR array.
4. Typical configuration current during T<sub>CONFIG</sub> is 10 mA.



## Internal Timing Parameters

Symbol	Parameter <sup>(1)</sup>	-6		-7		Units
		Min.	Max.	Min.	Max.	
<b>Buffer Delays</b>						
T <sub>IN</sub>	Input buffer delay	-	2.0	-	2.6	ns
T <sub>DIN</sub>	Direct data register input delay	-	3.7	-	5.3	ns
T <sub>GCK</sub>	Global Clock buffer delay	-	1.5	-	2.1	ns
T <sub>GSR</sub>	Global set/reset buffer delay	-	1.6	-	3.5	ns
T <sub>GTS</sub>	Global 3-state buffer delay	-	2.1	-	3.0	ns
T <sub>OUT</sub>	Output buffer delay	-	2.3	-	2.6	ns
T <sub>EN</sub>	Output buffer enable/disable delay	-	3.8	-	4.5	ns
<b>P-term Delays</b>						
T <sub>CT</sub>	Control term delay	-	1.2	-	1.4	ns
T <sub>LOGI1</sub>	Single P-term delay adder	-	0.5	-	1.1	ns
T <sub>LOGI2</sub>	Multiple P-term delay adder	-	0.3	-	0.5	ns
<b>Macrocell Delay</b>						
T <sub>PDI</sub>	Input to output valid	-	0.9	-	0.7	ns
T <sub>LDI</sub>	Setup before clock (transparent latch)	-	2.1	-	2.5	ns
T <sub>SUI</sub>	Setup before clock	1.4	-	1.4	-	ns
T <sub>HI</sub>	Hold after clock	0.0	-	0.0	-	ns
T <sub>ECSU</sub>	Enable clock setup time	1.4	-	1.6	-	ns
T <sub>ECHO</sub>	Enable clock hold time	0.0	-	0.0	-	ns
T <sub>COI</sub>	Clock to output valid	-	0.4	-	0.7	ns
T <sub>AOI</sub>	Set/reset to output valid	-	1.1	-	1.5	ns
T <sub>CDBL</sub>	Clock doubler delay	-	0.0	-	0.0	ns
<b>Feedback Delays</b>						
T <sub>F</sub>	Feedback delay	-	1.8	-	3.4	ns
T <sub>OEM</sub>	Macrocell to global OE delay	-	2.0	-	2.6	ns
<b>I/O Standard Time Adder Delays 1.5V CMOS</b>						
T <sub>HYS15</sub>	Hysteresis input adder	-	3.0	-	4.0	ns
T <sub>OUT15</sub>	Output adder	-	0.8	-	1.0	ns
T <sub>SLEW15</sub>	Output slew rate adder	-	4.0	-	4.0	ns
<b>I/O Standard Time Adder Delays 1.8V CMOS</b>						
T <sub>HYS18</sub>	Hysteresis input adder	-	2.0	-	4.0	ns
T <sub>IN18</sub>	Input adder	-	0	-	0	ns
T <sub>OUT18</sub>	Output adder	-	0.0	-	0.0	ns
T <sub>SLEW18</sub>	Output slew rate adder	-	2.5	-	4.0	ns

### Internal Timing Parameters (Continued)

Symbol	Parameter <sup>(1)</sup>	-6		-7		Units
		Min.	Max.	Min.	Max.	
<b>I/O Standard Time Adder Delays 2.5V CMOS</b>						
T <sub>IN25</sub>	Standard input adder	-	0.6	-	0.7	ns
T <sub>HYS25</sub>	Hysteresis input adder	-	1.5	-	3.0	ns
T <sub>OUT25</sub>	Output adder	-	0.8	-	0.9	ns
T <sub>SLEW25</sub>	Output slew rate adder	-	3.0	-	4.0	ns
<b>I/O Standard Time Adder Delays 3.3V CMOS/TTL</b>						
T <sub>IN33</sub>	Standard input adder	-	0.5	-	0.6	ns
T <sub>HYS33</sub>	Hysteresis input adder	-	1.2	-	3.0	ns
T <sub>OUT33</sub>	Output adder	-	1.2	-	1.4	ns
T <sub>SLEW33</sub>	Output slew rate adder	-	3.0	-	4.0	ns
<b>I/O Standard Time Adder Delays HSTL, SSTL</b>						
SSTL2-1	Input adder to T <sub>IN</sub> , T <sub>DIN</sub> , T <sub>GCK</sub> , T <sub>GSR</sub> , T <sub>GTS</sub>	-	0.8	-	2.5	ns
	Output adder to T <sub>OUT</sub>	-	0.5	-	0.5	ns
SSTL3-1	Input adder to T <sub>IN</sub> , T <sub>DIN</sub> , T <sub>GCK</sub> , T <sub>GSR</sub> , T <sub>GTS</sub>	-	0.8	-	2.5	ns
	Output adder to T <sub>OUT</sub>	-	0.5	-	0.5	ns
HSTL-1	Input adder to T <sub>IN</sub> , T <sub>DIN</sub> , T <sub>GCK</sub> , T <sub>GSR</sub> , T <sub>GTS</sub>	-	2.0	-	2.5	ns
	Output adder to T <sub>OUT</sub>	-	0.0	-	0.0	ns

**Notes:**

1. 1.5 ns input pin signal rise/fall.

### Switching Characteristics

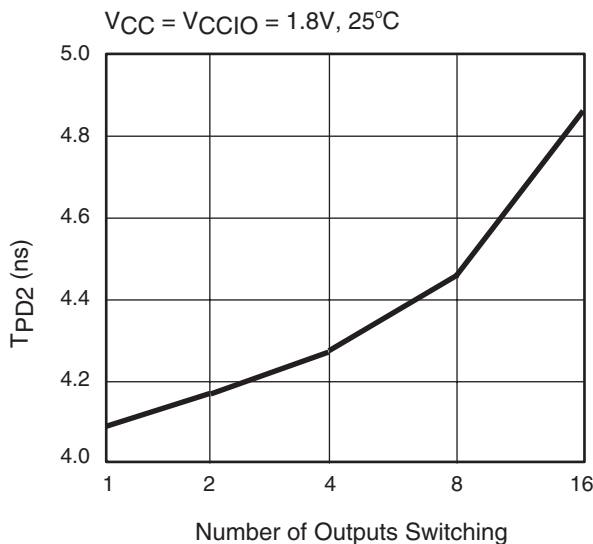

DS093\_02\_050103

Figure 2: Derating Curve for T<sub>PD</sub>

### Switching Test Conditions

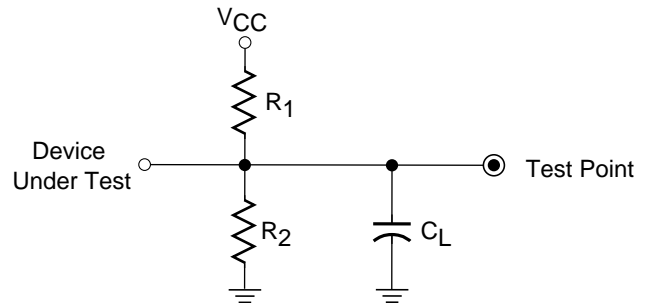

Output Type	R <sub>1</sub>	R <sub>2</sub>	C <sub>L</sub>
LVTTTL33	268Ω	235Ω	35 pF
LVC MOS33	275Ω	275Ω	35 pF
LVC MOS25	188Ω	188Ω	35 pF
LVC MOS18	112.5Ω	112.5Ω	35 pF
LVC MOS15	150Ω	150Ω	35 pF

**Notes:**

1. C<sub>L</sub> includes test fixtures and probe capacitance.
2. 1.5 nsec maximum rise/fall times on inputs.

Figure 3: AC Load Circuits

### Typical I/V Output Curves

The I/V curve illustrates the nominal amount of current that an I/O can source/sink at different voltage levels.

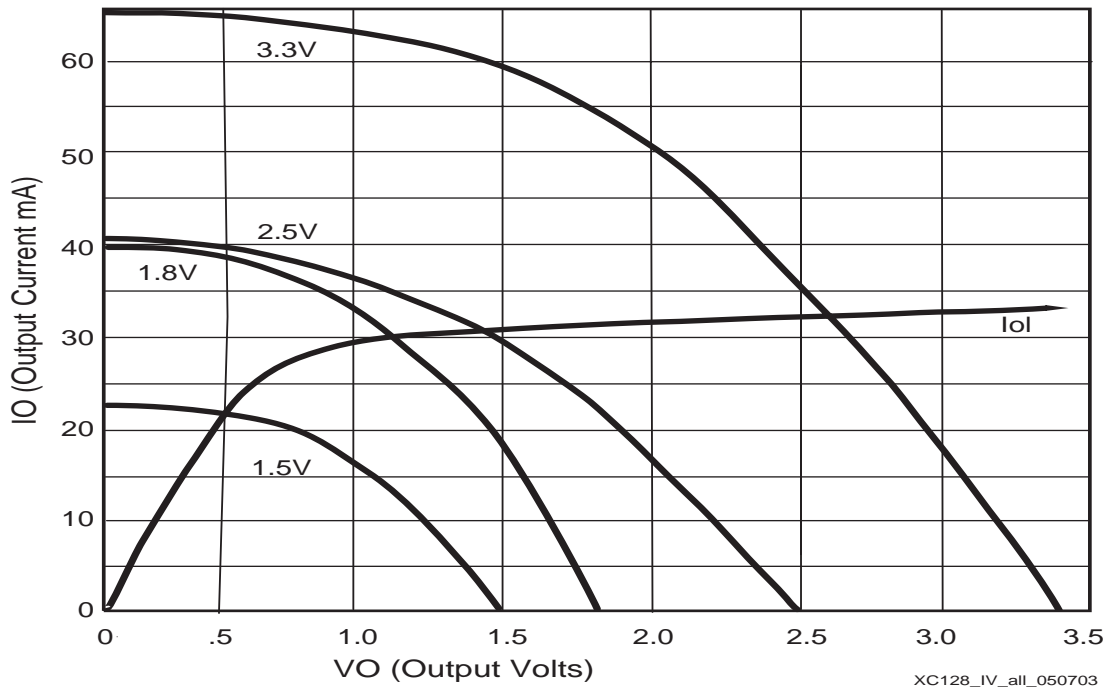

Figure 4: Typical I/V Curves for XC2C128

### Pin Descriptions

Function Block	Macro-cell	VQ100	CP132	TQ144	I/O Bank
1	1	13	G1	17	2
1	2	-	F1	16	2
1	3	12	F2	15	2
1	4	11	F3	14	2
1	5	10	E1	13	2
1	6	9	E2	12	2
1	7	-	-	-	-
1	8	-	-	-	-
1	9	-	-	-	-
1	10	-	-	-	-
1	11	8	E3	11	2
1	12	7	D1	10	2
1	13	6	D2	9	2
1	14	-	C1	7	2
1(GTS1)	15	4	C2	6	2
1(GTS0)	16	3	C3	5	2

### Pin Descriptions (Continued)

Function Block	Macro-cell	VQ100	CP132	TQ144	I/O Bank
2	1	-	G2	19	1
2	2	14	G3	21	1
2	3	15	H1	22	1
2	4	16	H2	23	1
2	5	17	H3	24	1
2	6	18	J1	25	1
2	7	-	-	-	-
2	8	-	-	-	-
2	9	-	-	-	-
2	10	-	-	-	-
2	11	19	J2	26	1
2	12	-	K1	28	1
2(GCK0)	13	22	K3	30	1
2(GCK1)	14	23	L2	32	1
2(CDRST)	15	24	M2	35	1
2(GCK2)	16	27	N2	38	1

**Pin Descriptions (Continued)**

Function Block	Macro-cell	VQ100	CP132	TQ144	I/O Bank
3	1	-	B1	4	2
3(GTS3)	2	2	B2	3	2
3(GTS2)	3	1	A1	2	2
3(GSR)	4	99	A3	143	2
3	5	97	B4	140	2
3	6	96	A4	138	2
3	7	95	C5	136	2
3	8	-	-	-	-
3	9	-	-	-	-
3	10	-	-	-	-
3	11	94	B5	134	2
3	12		A5	133	2
3	13	93	C6	132	2
3	14	92	B6	131	2
3	15	91	A6	130	2
3	16	90	C7	129	2
4(DGE)	1	28	P2	39	1
4	2	-	M3	40	1
4	3	-	N3	41	1
4	4	29	P3	43	1
4	5	30	M4	45	1
4	6	32	M5	49	1
4	7	33	N5	50	1
4	8	-	-	-	-
4	9	-	-	-	-
4	10	-	-	-	-
4	11	34	P5	51	1
4	12	35	M6	52	1
4	13	36	N6	53	1
4	14	37	P6	54	1
4	15	39	N7	56	1
4	16	40	M7	57	1

**Pin Descriptions (Continued)**

Function Block	Macro-cell	VQ100	CP132	TQ144	I/O Bank
5	1	65	G13	94	2
5	2	66	G12	95	2
5	3	67	F14	96	2
5	4	-	F13	97	2
5	5	68	F12	98	2
5	6	-	E13	100	2
5	7	70	E12	101	2
5	8	-	-	-	-
5	9	-	-	-	-
5	10	-	-	-	-
5	11	71	D14	102	2
5	12	72	D13	103	2
5	13	73	D12	104	2
5	14	74	C14	105	2
5	15	76	B13	110	2
5	16	-	A13	111	2
6	1	64	H12	92	1
6	2	63	H13	91	1
6	3	61	J13	88	1
6	4	60	J12	87	1
6	5	59	K14	86	1
6	6	58	K13	85	1
6	7	-	-	-	-
6	8	-	-	-	-
6	9	-	-	-	-
6	10	-	-	-	-
6	11	-	L14	83	1
6	12	56	L13	82	1
6	13	-	L12	81	1
6	14	55	M14	80	1
6	15	-	M13	79	1
6	16	54	M12	78	1

### Pin Descriptions (Continued)

Function Block	Macro-cell	VQ100	CP132	TQ144	I/O Bank
7	1	77	C12	112	2
7	2	78	B12	113	2
7	3	-	A12	115	2
7	4	79	C11	116	2
7	5	80	B11	117	2
7	6	81	A11	118	2
7	7	-	C10	119	2
7	8	-	-	-	-
7	9	-	-	-	-
7	10	-	-	-	-
7	11	82	A10	120	2
7	12	-	C9	121	2
7	13	85	A8	124	2
7	14	86	B8	125	2
7	15	87	C8	126	2
7	16	89	B7	128	2

### Pin Descriptions (Continued)

Function Block	Macro-cell	VQ100	CP132	TQ144	I/O Bank
8	1	-	N14	77	1
8	2	53	N13	76	1
8	3	52	P14	74	1
8	4	50	P12	71	1
8	5	-	M11	70	1
8	6	49	N11	69	1
8	7	-	-	-	-
8	8	-	-	-	-
8	9	-	-	-	-
8	10	-	-	-	-
8	11	-	P11	68	1
8	12	46	P10	64	1
8	13	44	P9	61	1
8	14	43	M8	60	1
8	15	42	N8	59	1
8	16	41	P8	58	1

#### Notes:

1. GTS = global output enable, GSR = global reset/set, GCK = global clock, CDRST = clock divide reset, DGE = DataGATE enable.
2. GCK, GSR, and GTS pins can also be used for general purpose I/O.

**XC2C128 JTAG, Power/Ground, No Connect Pins and Total User I/O**

Pin Type	VQ100 <sup>(1)</sup>	CP132 <sup>(1)</sup>	TQ144 <sup>(1)</sup>
TCK	48	M10	67
TDI	45	M9	63
TDO	83	B9	122
TMS	47	N10	65
V <sub>CCAUX</sub> (JTAG supply voltage)	5	D3	8
Power internal (V <sub>CC</sub> )	26, 57	P1, K12, A2	1, 37, 84
Power Bank 1 I/O (V <sub>CCIO1</sub> )	20, 38, 51	J3, P7, G14, P13	27, 55, 73, 93
Power Bank 2 I/O (V <sub>CCIO2</sub> )	88, 98	A14, C4, A7	109, 127, 141
Ground	21, 25, 31, 62, 69, 75, 84, 100	K2, N1, P4, N9, N12, J14, H14, E14, B14, A9, B3	29, 36, 47, 62, 72, 89, 90, 99, 108, 123, 144
No connects	-	L1, L3, M1, N4, C13, B10	18, 20, 31, 33, 34, 42, 44, 46, 48, 66, 75, 106, 107, 114, 135, 137, 139, 142
Total user I/O (including dual function pins)	80	100	100

**Notes:**

1. Pin compatible with all larger and smaller densities except where I/O banking is used.

**Ordering Information**

Part Number	Pin/Ball Spacing	$\theta_{JA}$ (C/Watt)	$\theta_{JC}$ (C/Watt)	Package Type	Package Body Dimensions	I/O	Comm. (C) Ind. (I) <sup>(1)</sup>
XC2C128-6VQ100C	0.5mm	47.5	12.5	Very Thin Quad Flat Pack	14mm x 14mm	80	C
XC2C128-7VQ100C	0.5mm	47.5	12.5	Very Thin Quad Flat Pack	14mm x 14mm	80	C
XC2C128-6CP132C	0.5mm	72.4	15.7	Chip Scale Package	8mm x 8mm	100	C
XC2C128-7CP132C	0.5mm	72.4	15.7	Chip Scale Package	8mm x 8mm	100	C
XC2C128-6TQ144C	0.5mm	46.1	7.9	Thin Quad Flat Pack	20mm x 20mm	100	C
XC2C128-7TQ144C	0.5mm	46.1	7.9	Thin Quad Flat Pack	20mm x 20mm	100	C
XC2C128-6VQG100C	0.5mm	47.5	12.5	Very Thin Quad Flat Pack; Pb-free	14mm x 14mm	80	C
XC2C128-7VQG100C	0.5mm	47.5	12.5	Very Thin Quad Flat Pack; Pb-free	14mm x 14mm	80	C
XC2C128-6CPG132C	0.5mm	72.4	15.7	Chip Scale Package; Pb-free	8mm x 8mm	100	C
XC2C128-7CPG132C	0.5mm	72.4	15.7	Chip Scale Package; Pb-free	8mm x 8mm	100	C
XC2C128-6TQG144C	0.5mm	46.1	7.9	Thin Quad Flat Pack; Pb-free	20mm x 20mm	100	C
XC2C128-7TQG144C	0.5mm	46.1	7.9	Thin Quad Flat Pack; Pb-free	20mm x 20mm	100	C
XC2C128-7VQ100I	0.5mm	47.5	12.5	Very Thin Quad Flat Pack	14mm x 14mm	80	I

Part Number	Pin/Ball Spacing	$\theta_{JA}$ (C/Watt)	$\theta_{JC}$ (C/Watt)	Package Type	Package Body Dimensions	I/O	Comm. (C) Ind. (I) <sup>(1)</sup>
XC2C128-7CP132I	0.5mm	72.4	15.7	Chip Scale Package	8mm x 8mm	100	I
XC2C128-7TQ144I	0.5mm	46.1	7.9	Thin Quad Flat Pack	20mm x 20mm	100	I
XC2C128-7VQG100I	0.5mm	47.5	12.5	Very Thin Quad Flat Pack; Pb-free	14mm x 14mm	80	I
XC2C128-7CPG132I	0.5mm	72.4	15.7	Chip Scale Package; Pb-free	8mm x 8mm	100	I
XC2C128-7TQG144I	0.5mm	46.1	7.9	Thin Quad Flat Pack; Pb-free	20mm x 20mm	100	I

Notes: C = Commercial (T<sub>A</sub> = 0° C to +70° C); I = Industrial (T<sub>A</sub> = -40° C to +85° C).

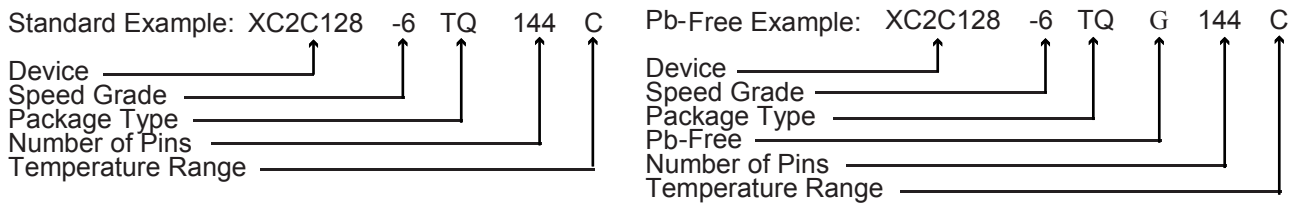

## Device Part Marking

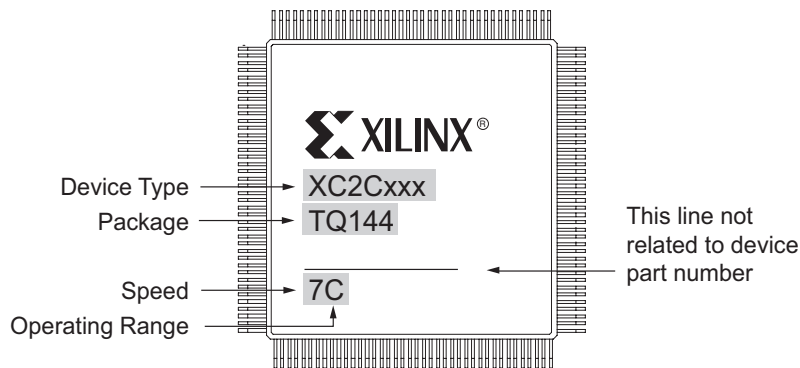

Part Marking for all non chip scale packages

Figure 5: Sample Package with Part Marking

Note: Due to the small size of chip scale packages, the complete ordering part number cannot be included on the package marking. Part marking on chip scale packages by line are:

- Line 1 = X (Xilinx logo) then truncated part number
- Line 2 = Not related to device part number
- Line 3 = Not related to device part number
- Line 4 = Package code, speed, operating temperature, three digits not related to device part number. Package codes: C5 = CP132, C6 = CPG132.

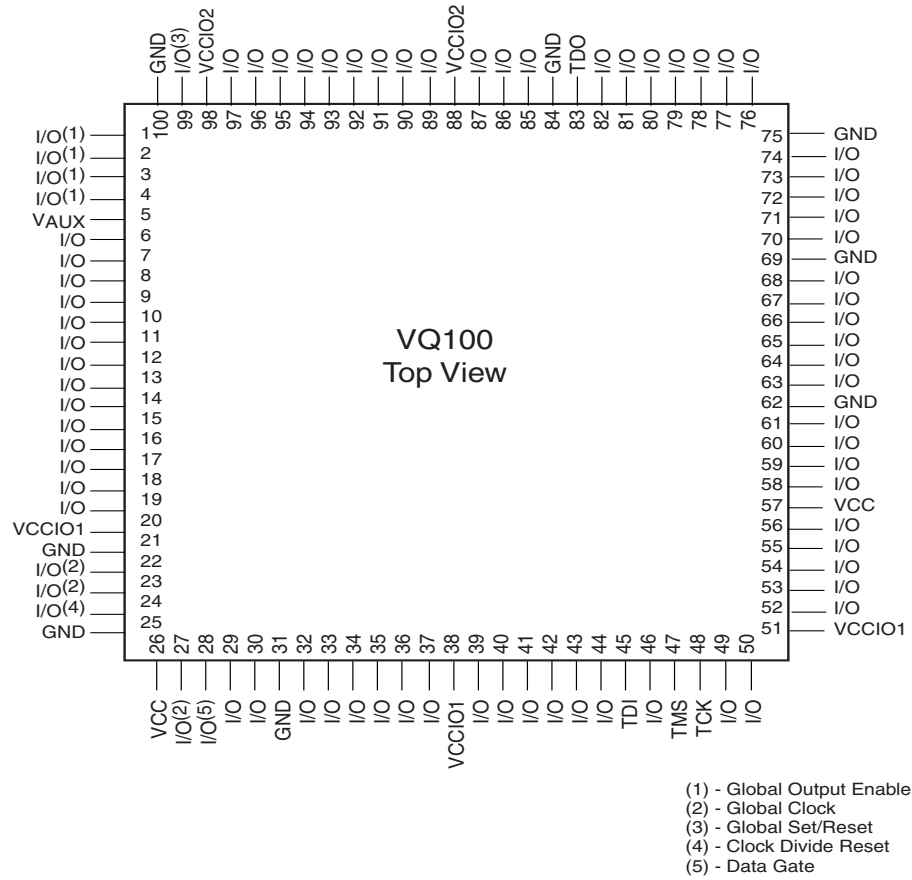
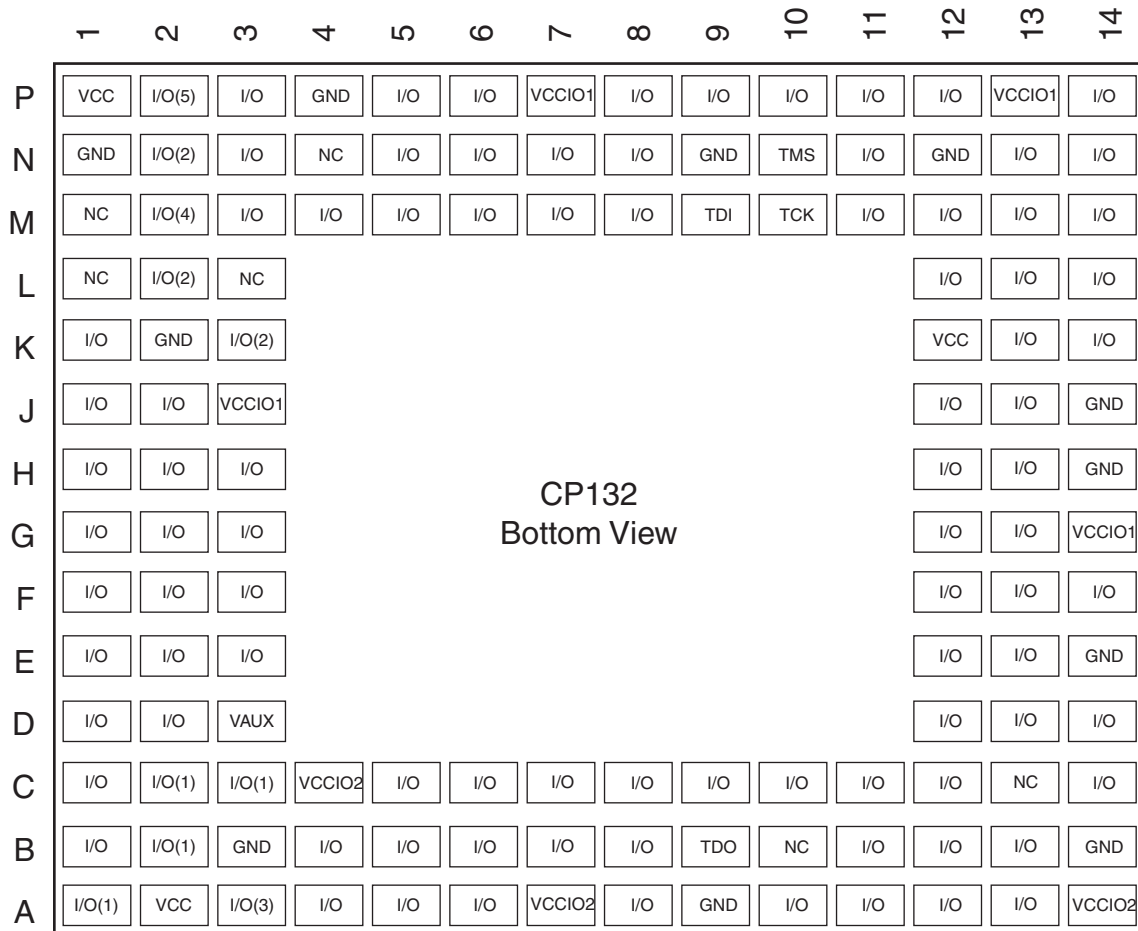

Figure 6: VQ100 Very Thin Quad Flat Pack





- (1) - Global Output Enable
- (2) - Global Clock
- (3) - Global Set/Reset
- (4) - Clock Divide Reset
- (5) - DataGATE Enable

Figure 7: CP132 Chip Scale Package

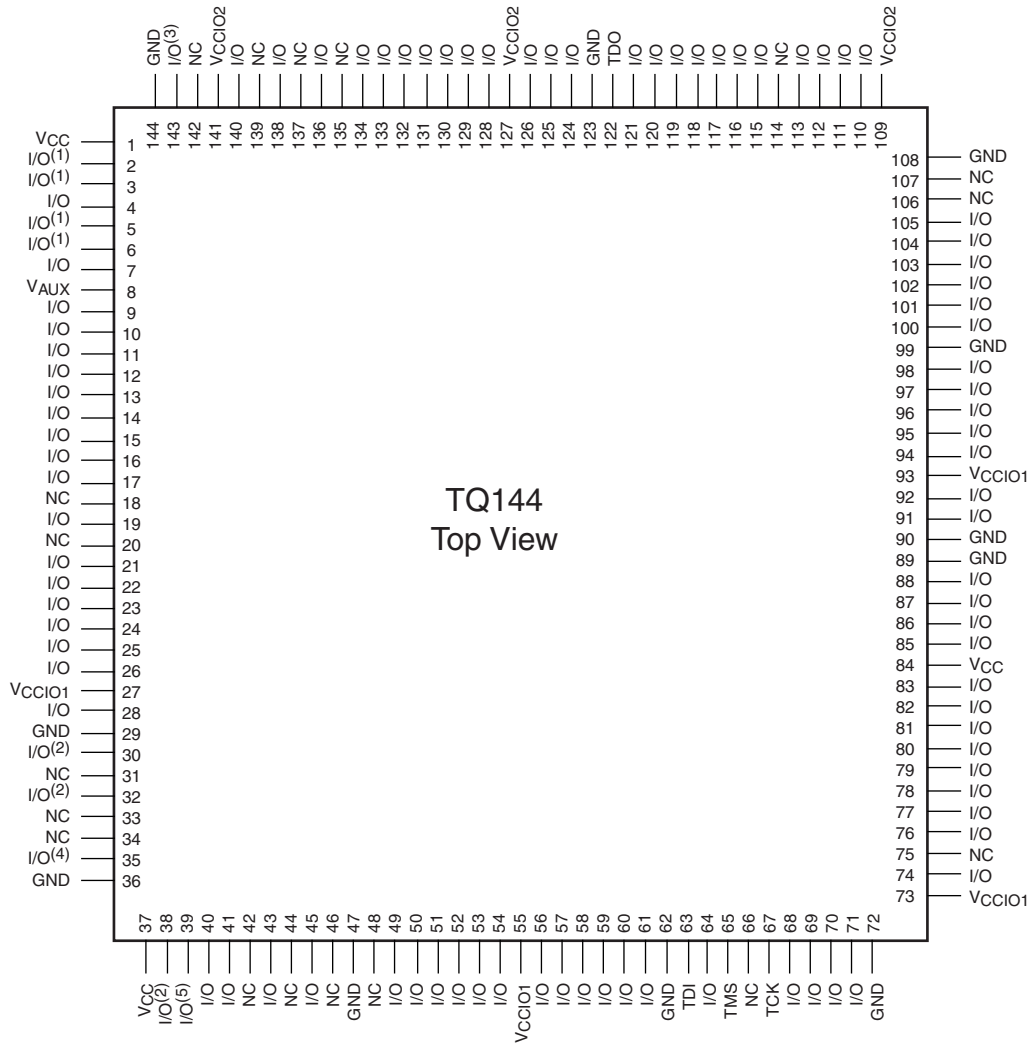

- (1) - Global Output Enable
- (2) - Global Clock
- (3) - Global Set/Reset
- (4) - Clock Divide Reset
- (5) - DataGATE Enable

Figure 8: TQ144 Thin Quad Flat Pack

## Warranty Disclaimer

THESE PRODUCTS ARE SUBJECT TO THE TERMS OF THE XILINX LIMITED WARRANTY WHICH CAN BE VIEWED AT <http://www.xilinx.com/warranty.htm>. THIS LIMITED WARRANTY DOES NOT EXTEND TO ANY USE OF THE PRODUCTS IN AN APPLICATION OR ENVIRONMENT THAT IS NOT WITHIN THE SPECIFICATIONS STATED ON THE THEN-CURRENT XILINX DATA SHEET FOR THE PRODUCTS. PRODUCTS ARE NOT DESIGNED TO BE FAIL-SAFE AND ARE NOT WARRANTED FOR USE IN APPLICATIONS THAT POSE A RISK OF PHYSICAL HARM OR LOSS OF LIFE. USE OF PRODUCTS IN SUCH APPLICATIONS IS FULLY AT THE RISK OF CUSTOMER SUBJECT TO APPLICABLE LAWS AND REGULATIONS.

## Additional Information

Additional information is available for the following CoolRunner-II topics:

- XAPP784: Bulletproof CPLD Design Practices
- XAPP375: Timing Model
- XAPP376: Logic Engine
- XAPP378: Advanced Features
- XAPP382: I/O Characteristics
- XAPP389: Powering CoolRunner-II
- XAPP399: Assigning VREF Pins

To access these and all application notes with their associated reference designs, click the following link and scroll down the page until you find the document you want:

[CoolRunner-II Data Sheets and Application Notes](#)

[Device Packages](#)

## Revision History

The following table shows the revision history for this document.

Date	Version	Revision
10/01/02	1.0	Initial Xilinx release.
5/19/03	2.0	Added bin 6, 7 characterization data.
8/25/03	2.1	Edit Package diagram, other minor formatting edits.
01/26/04	2.2	Update links.
03/01/04	2.3	Fixed cropping on Figure 6.
7/30/04	2.4	Added Pb-free documentation.
10/01/04	2.5	Add Asynchronous Preset/Reset Pulse Width specification to AC Electrical Characteristics.
01/30/05	2.6	Change to $I_{CCSB}$ MAX for Commercial and Industrial.
03/07/05	2.7	Delete -4 speed grade. Modifications to Table 1, IOSTANDARDS.
04/21/05	2.8	Recharacterization of AC Specifications
06/28/05	2.9	Move to Product Specification.
03/20/06	3.0	Add Warranty Disclaimer. Add note to Pin Descriptions that GCK, GSR, and GTS pins can also be used for general purpose I/O. Replaced Figure 3 with a higher resolution graphic.
02/15/07	3.1	Corrections to timing parameters $t_F$ , $t_{CT}$ , $t_{DIN}$ , $t_{GTS}$ , $t_{OEM}$ and $f_{TOGGLE}$ for -6 speed grade. Corrections to $t_{DIN}$ , $t_{GCK}$ , $t_{EN}$ , $t_{SUI}$ , $t_{ECSU}$ , $t_F$ , $t_{OEM}$ , $F_{EXT1}$ , and $F_{EXT2}$ for the -7 speed grade. Values now match the software. There were no changes to silicon or characterization. Change to $V_{IH}$ specification for 2.5V and 1.8V LVCMOS.
03/08/07	3.2	Fixed typo in note for $V_{IL}$ for LVCMOS18; removed note for $V_{IL}$ for LVCMOS33.



**In Clear Electronics**

[WWW.IC-1000.COM](http://WWW.IC-1000.COM)

## THE DATASHEET OF FPGA



[www.ic-1000.com](http://www.ic-1000.com)



[info@ic-1000.com](mailto:info@ic-1000.com)



[+00852-56412601](tel:+00852-56412601)



[+00852-56412601](https://wa.me/0085256412601)



Unit B, 13/F, Shing Lee Commercial Building  
No.8 Wing Kut Street, Central HK